

DESCRIPTION

- 1-1/4" smart home water monitoring and leak detection system

OPERATION

- Remote, automatic, and manual water on/off (shut-off) capability
- WiFi enabled device for smartphone connectivity
- Smartphone app available for iOS and Android that provides the following:
 - Proactive maintenance alerts (i.e. leak alert, pressure alerts, etc.)
 - Remote water control and shut-off
 - Set water consumption goals and monitor water usage
 - Set system modes (home, away, sleep)
 - See real-time flow, pressure, and temperature readings
 - Run manual leak detection tests "Health Tests"
- Works with Amazon Alexa, Google Assistant, IFTTT and Control4

FLOW

- Maximum operating pressure of 175 psi

STANDARDS

- Smart Home Water Security System third party certified by: IAPMO IGC-349-2017 and all applicable requirements referenced therein
- UL 1951, CSA C22.2 Nos. 14 and 68
- Certified to NSF 61/9 & 372
- Third party certified to meet FCC part 15 Class B (power adapter)
- Third party certified to meet Industry Canada RSS-210
- UL 60950, UL 1310, CSA C22.2 #223, CE EN 60950
- UL 1951, CSA C22.2 No. 68, CSA C22 No.14
- FCC ID: PU5900-001 to CFR 47 Part 15 Subpart C (Flo by Moen device)
- IPX5 (protection from sprayed jets in any direction)

WARRANTY

- Flo Technologies warrants that the product will be free from defects in materials and workmanship for a period of one (1) year from the date of delivery following the original retail purchase
- Extended product warranty available through FloProtect plan

Visit www.support.meetflo.com for complete details and limitations

Installation Notes:

- Install product following the installation guide
- Must be installed on accessible main water supply line (cold water line) that is 1.25 inch diameter (can be installed on 1.50 inch diameter or smaller)
- Must be installed after water meter, water shut-off, and pressure regulating valve (if applicable)
- Power supply and device must not be installed where the ambient temperature can exceed 140 deg F (60 deg C) or below 32 deg F (0 deg C)
- Requires electrical outlet (100-240VAC-50/60 Hz) with continuous power within 6 feet of device
- Requires WiFi network (WLAN connectivity/IEEE 802.11bgn, 2.4 GHz range)
- Smartphone (iPhone or Android) with installed app required

For Well Pump System Installations:

- When installed on well or irrigation water service lines, the device should be placed after (downstream) of all treatment and filtration components to avoid debris interference. It should also be installed after the well pump and water storage tank. If it is necessary to install the device prior to a water filtration system, a wye strainer with a 100 mesh or finer screen and blow-down port is required to catch any sediment or particles from the ground source or casing. The mesh screen in the strainer may require periodic maintenance.



Flo by Moen™ Smart Home Water Monitoring and Leak Detection System

Model: 900-002

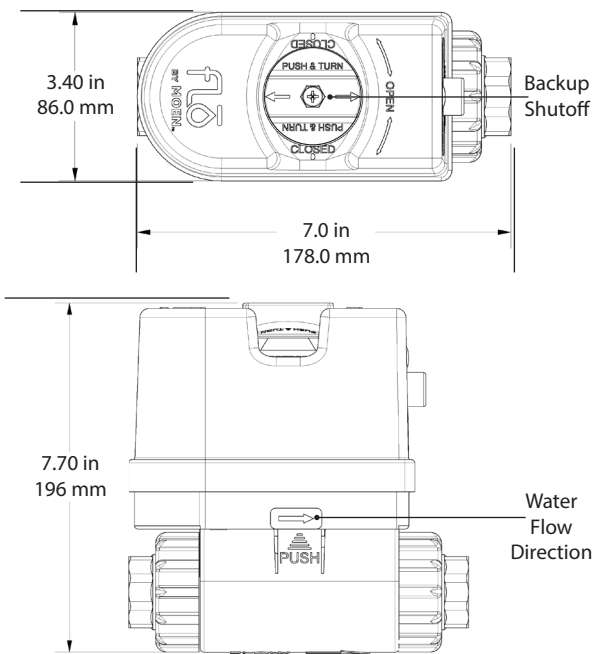
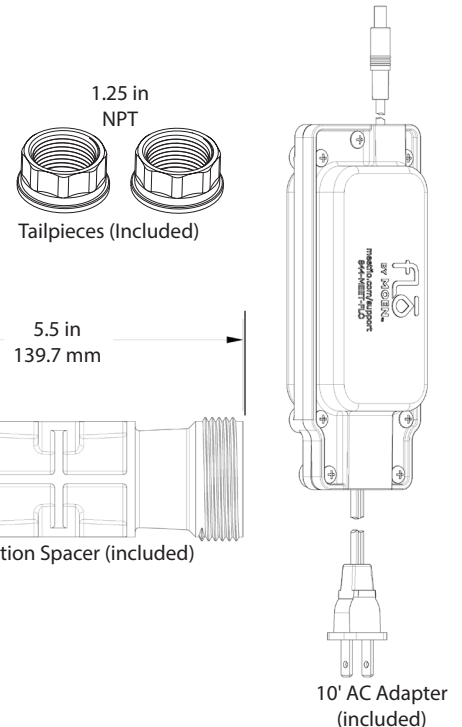

CRITICAL DIMENSIONS

(DO NOT SCALE)

Included with product: 1-1/4" inch-NPT threaded brass tailpieces (x2), AC adapter (12 VDC, 100-240VAC-50/60 Hz) with 10' cable (x1), spare o-rings (x2), installation spacer (x1), 3/8" hex key (x1)